

ICS 25.020

Supersedes
SN 200-5:2016-05**Table of contents**

	Page
Introduction	1
1 Scope	1
2 Normative references	2
3 Mechanical processing	3
3.1 General notes	3
3.2 Mechanical processing before and/or after welding in or welding on	3
3.3 Free choice of tool	3
3.4 Workpiece edges	6
3.5 Threads	7
3.6 Surface qualities	7
3.7 Heat treatment	7
4 General tolerances	8
4.1 Lengths, angles, radii of curvature and chamfer heights	8
4.2 Shape and position	10
5 Inspection	13
5.1 Basic specifications	13
5.2 Requirements for measuring equipment	13
5.3 Inspection documentation	13
5.4 Tolerances and limit deviations for linear sizes from 1 to 10,000 mm	14
Annex A (informative) Representation on drawings	18
Annex B (informative) Surface roughness values	20
Amendments	20
Previous editions	20

This copy will not be updated in case of changes !

Introduction

The manufacturing requirements specified in this part of SN 200 are used to achieve the relevant SMS product quality. Consequently, these requirements must always be satisfied unless otherwise stipulated in drawings, purchase order documents, and/or other manufacturing documents. This standard is indicated as a binding document in drawings (title blocks), contracts and/or purchase order documents. If the requirements cannot be fulfilled, SMS group must be consulted.

1 Scope

This company standard defines for SMS group the manufacturing specifications and inspections for parts which are used as starting material and/or manufacturing material in SMS group products and which undergo metal cutting working (machining).

2 Normative references

The following documents, quoted herein either in whole or in part, are required for the application of the present document. Dated references refer only to the edition of the date indicated. Undated references refer to the most recent edition of the respective document inclusive of all revisions.

DIN 30-10	Technical drawings - Simplified drawing - Part 10: Simplified indications and collective indication, execution
DIN 76-1	Thread run-outs and thread undercuts - Part 1: For ISO metric threads in accordance with DIN 13-1
DIN 76-2	Thread run-outs and thread undercuts for pipe threads conforming to ISO 228 Part 1
DIN 7168:1991-04	General tolerances for linear and angular dimensions and geometrical tolerances
DIN 2769:2021-12	Geometrical product specification (GPS) - General tolerances - Tolerances for linear and angular dimensions with unspecified tolerance indication
DIN 7172:1991-04	Tolerances and limit deviations for sizes above 3150 mm up to 10000 mm; principles, standard tolerances and limit deviations
DIN EN 10204:2005-01	Metallic products - Types of inspection documents
DIN EN ISO 1:2016-12	Geometrical product specifications (GPS) - Standard reference temperature for the specification of geometrical and dimensional properties
DIN EN ISO 129-1	Technical product documentation (TPD) - Presentation of dimensions and tolerances - Part 1: General principles
DIN EN ISO 286-2: 2019-09	Geometrical product specification (GPS) - ISO code system for tolerances on linear sizes - Part 2: Tables of standard tolerance classes and limit deviations for holes and shafts
DIN EN ISO 1101:2017-09	Geometrical product specifications (GPS) - Geometrical tolerancing - Tolerances of form, orientation, location and run-out
DIN EN ISO 1302: 2002-06	Geometrical Product Specifications (GPS) - Indication of surface texture in technical product documentation
DIN EN ISO 9001:2015-11	Quality management systems - Requirements
DIN EN ISO 10012	Measurement management systems - Requirements for measurement processes and measuring equipment
DIN EN ISO 13715:2020-01	Technical product documentation - Edges of undefined shape - Indication and dimensioning
DIN ISO 965-1:2017-05	ISO general purpose metric screw threads - Tolerances - Part 1: Principles and basic data
DIN ISO 2768-2:1991-04	General tolerances; geometrical tolerances for features without individual tolerances indications
ISO 10474:2013-07	Steel and steel products - Inspection documents
SN 200-1	Manufacturing Instructions; Requirements and principles
SN 200-8	Manufacturing instructions – Inspection
SN 480-2:2015-09	Drilling dimensions; Through-holes for bolts

3 Mechanical processing

3.1 General notes

The SMS group-specific information and symbols and their meaning are defined in the following subsections. If these symbols are indicated in the drawing, the corresponding design shall be carried out.

3.2 Mechanical processing before and/or after welding in or welding on

If the following symbols are used for mechanical processing in the manufacturing documents, the specifications shall be observed as specified in Table 1.

Table 1 – Mechanical processing

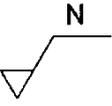
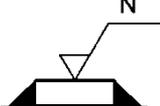
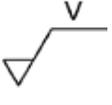
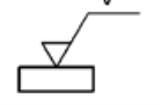
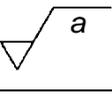
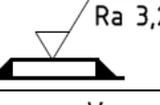
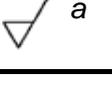
Symbol	Explanation	Example of drawing indication
	The surface marked with this symbol shall be processed mechanically <u>after</u> welding in or welding on. No specification of the surface quality to be achieved.	
	The surface marked with this symbol shall be processed mechanically <u>before</u> welding in or welding on. No specification of the surface quality to be achieved.	
	The surface marked with this symbol shall be processed mechanically <u>after</u> welding in or welding on. The surface parameter Ra is entered with a figure in µm at position a.	
	The surface marked with this symbol shall be processed mechanically <u>before</u> welding in or welding on. The surface parameter Ra is entered with a figure in µm at position a.	

3.3 Free choice of tool

3.3.1 Basic specifications

Curvatures, chamfers, keyways, bore mouths and end faces of recesses that are identified by a symbol as shown in Fig. 1 can be performed according to the tool contour and thus may differ from the exact representation on the drawing. Tool contours that are excluded are mentioned in the symbol shown in Fig. 2. The different cases are shown and explained in the following subsections.

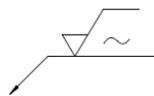

Fig. 1 - Free choice of tool,
Variant A

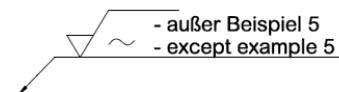
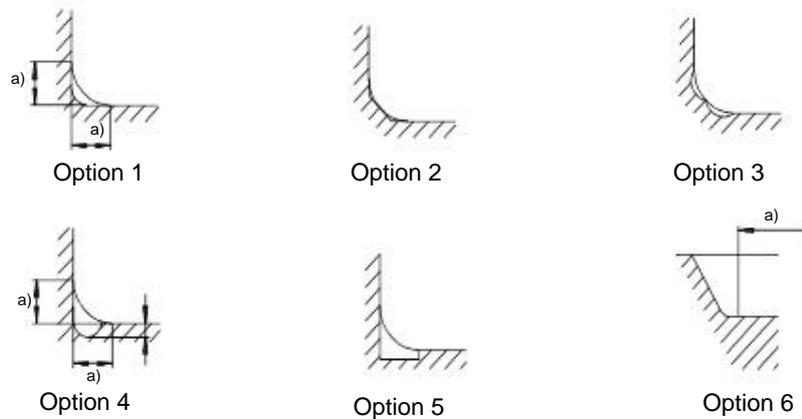

Fig. 2 - Free choice of tool,
Variant B (example)

3.3.2 Curvatures, chamfers

If curvatures or chamfers are identified in the drawing of variant A according to Fig. 1, they can be performed (free choice of tool) according to the options given in Fig. 3.
 If variant B is shown according to Fig. 2, the corresponding example given in Fig. 3 must not be performed.



a) with indication of functional dimensions

Fig. 3 – Design options

3.3.3 Grooves and recesses

If grooves are identified in the drawing of variant A according to Fig. 1, they may be performed (free choice of tool) according to the options given in Fig. 3.



Fig. 4 – Design options

If the drawing indication is made for several recesses, as shown in the example of Fig. 5, it is possible to mill a common end face/recess as shown in Fig. 6.

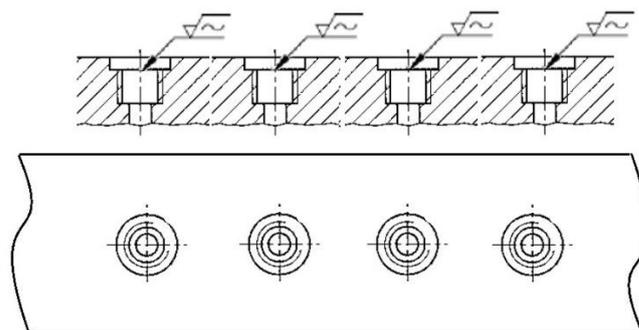

Fig. 5 – End faces of recesses as per drawing

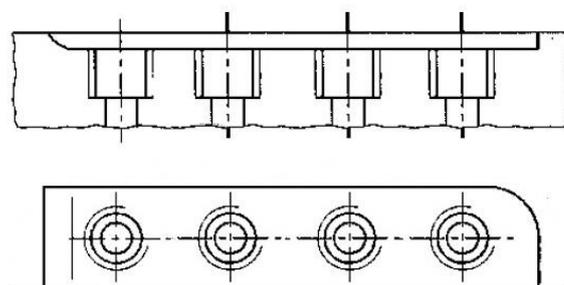

Fig. 6– Example as executed

3.3.4 Holes

3.3.4.1 Drilling tool runout

If the drawing shows Variant A for holes, according to Fig. 7, the variant may be executed by the manufacturer according to the options given in Fig. 8.

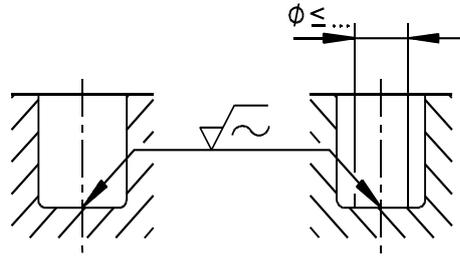
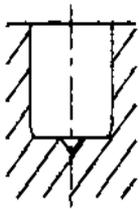
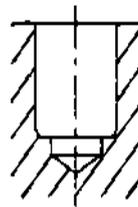

Fig. 7 – Drilling tool runout, drawing indication Variant A



Option 9



Option 10

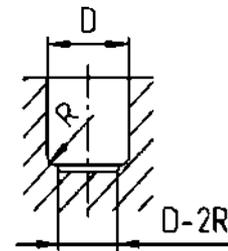

Option 11

Fig. 8 – Design options

3.3.4.2 Choice of drilling tool for stepped holes

For performing a stepped (deep drill) hole as marked in Fig. 9, the manufacturer may choose the bore diameter (in the example, it is between 11 mm and 16.5 mm) that follows the thread. A through-hole having the diameter of the core hole may also be drilled.

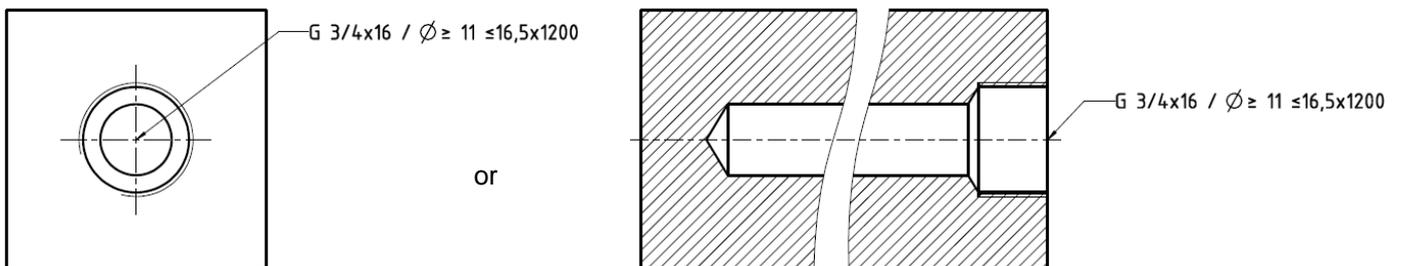

Fig. 9 – Free choice of drilling tool, drawing indication (example)

3.4 Workpiece edges

All workpiece edges produced by mechanical processing shall be deburred according to [DIN EN ISO 13715:2020-01](#), see Fig. 10 and Fig. 11.

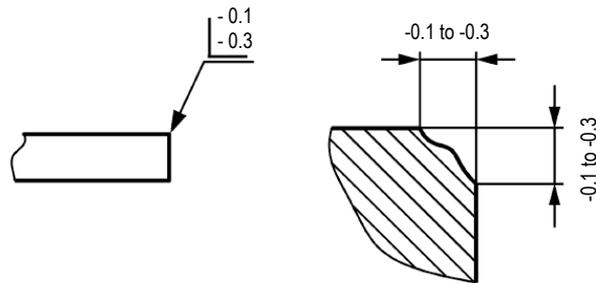

Fig. 10 – Outer edge, free of burrs, removal - 0.1 to - 0.3

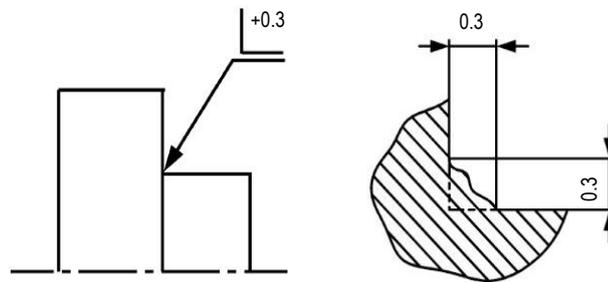

Fig. 11 – Inner edge, transition up to + 0.3

3.5 Threads

3.5.1 Tolerances for metric ISO threads

The following tolerances apply to metric ISO threads:

- Thread tolerance class according to [DIN ISO 965-1:2017-05](#) medium (m)
- Tolerance zone according to [DIN ISO 965-1: 2017-05](#) 6g for external thread (bolt)
- Tolerance zone according to [DIN ISO 965-1: 2017-05](#) 6H for internal thread (nut)

For parts shown on drawings, a drawing indication is made for thread sizes \geq M64.

3.5.2 Thread runouts/thread undercuts

All thread runouts and thread undercuts shall be the normal design according to [DIN 76-1](#) and [DIN 76-2](#).

3.6 Surface qualities

The SMS group drawings use the centerline average roughness Ra, according to [DIN EN ISO 1302:2002-06](#), as the preferred measured variable, see Annex A (informative). Table 2 shows the standard surface qualities used by SMS group when no drawing indications are made. They are also valid when the summarising symbol is shown. Annex B (informative) mentions the surface roughness values and the corresponding comparison.

Table 2 - Surface quality

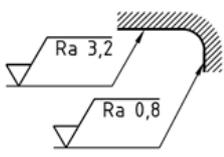
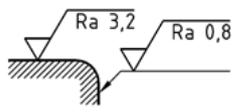
Application	Standard surface quality	
Linear dimensions referring to surfaces without indication of roughness variables (e.g. surfaces produced by sawing)	$\sqrt{Ra\ 50}$	
Holes up to dia 40 mm, oblong holes, keeper plate slots, chamfers	$\sqrt{Ra\ 25}$	
Rough-machined parts, weld-in parts	$\sqrt{Ra\ 25}$	
End faces		
- for bolt head and nut supports	$\sqrt{Ra\ 3,2}$	
- of recesses for bolt head and nut supports	$\sqrt{Ra\ 3,2}$	
Undercuts, threads, thread undercuts, keyways, lubrication grooves, end faces	$\sqrt{Ra\ 3,2}$	
The following applies to radii and/or curvatures:	Example 1	Example 2
- all inner curvatures, example 1, shall have the finer surface quality $\sqrt{Ra\ 0,8}$ of the adjoining surfaces,		
- all outer curvatures, example 2, shall have the coarser surface quality $\sqrt{Ra\ 3,2}$ of the adjoining surfaces,		

3.7 Heat treatment

Heat treatments required for reasons of manufacturing sequence (e.g. stresses resulting from machining) shall be made/arranged for by the executing workshop.

Surface treatment methods which are necessary to establish specific/required near-surface properties (thermochemical, thermomechanical, thermal or mechanical influencing) shall be performed independently by the executing workshop unless otherwise required.

4 General tolerances

4.1 Lengths, angles, radii of curvature and chamfer heights

4.1.1 Basic specifications

The general tolerances for linear and angular dimensions, radii of curvature and chamfer heights as per [DIN 2769:2021-12](#) shall be applied to machined parts. They apply to dimensions with no specified tolerances between two machined surfaces of a part made from any metallic material provided that no material-specifically deviating general tolerances have been defined in other specifications.

For dimensions between an unmachined surface and a machined surface of a part for which no individual tolerance is indicated, [SN 200-2](#) specifies that half the general tolerances specified in the corresponding standard for castings, torch-cut parts and forgings shall be applied.

An auxiliary dimension enclosed in brackets is a dimension that is not required for the geometrical definition (manufacture) of a part.

General tolerances do not apply to

- auxiliary dimensions enclosed in brackets according to [DIN EN ISO 129-1](#);
- non-indicated 90° angles between lines forming the axes of coordinates.

4.1.2 General tolerance values for linear sizes

Based on [DIN 2769:2021-12](#), the general tolerance values for linear sizes are specified in Table 3 for general linear dimensions (e.g. external, internal, stepped dimensions, diameters, radii, distance dimensions), in Table 4 for radii of curvature and chamfer heights (bevels) and in Table 5 for cutting length dimensions.

Table 3 – General linear dimensions (dimensions in mm)

Limit deviations for nominal dimension ranges	0.5 ^{b)} to 6	> 6 to 30	> 30 to 120	> 120 to 400	> 400 to 1000	> 1000 to 2000	> 2000 to 4000	> 4000 to 8000	> 8000 to 12000	> 12000 to 16000	> 16000 to 20000	
Tolerance	± 0.1	± 0.2	± 0.3	± 0.5	± 0.8	± 1.2	± 2	± 3	± 4	± 5	± 6	
Tolerance class	b ^{a)}							m ^{c)}				
a) according to DIN 2769:2021-12 b) Permissible limit deviations for nominal dimensions less than 0.5 mm are indicated directly with the nominal dimension. c) Tolerance class m according to DIN 7168:1991-04												

Table 4 – Radii of curvature and chamfer heights (dimensions in mm)

Limit deviations for nominal dimension ranges	0.5 ^{b)} to 3	> 3 to 6	> 6 to 30	> 30 to 120	> 120 to 400
Tolerance	± 0.3	± 0.5	± 1	± 1.2	± 2.5
Tolerance class	d ^{a)}				
a) according to DIN 2769:2021-12 b) Permissible limit deviations for nominal dimensions less than 0.5 mm are indicated directly with the nominal dimension.					

Table 5 - Cutting length dimensions (dimensions in mm)

Limit deviations for nominal dimension ranges	Up to 400	> 400 to 4000	> 4000 to 8000
Tolerance	± 1	± 2	± 3

4.1.3 General tolerance values for angular size dimensions

The general tolerance values for angular dimensions are specified on the basis of [DIN 2769:2021-12](#), and the pertaining tangent values for general angular dimensions are specified in Table 6 and for angular dimensions for lubrication holes in Table 7.

Lubrication holes can be identified by the metric thread and/or inch thread used at one end of the hole/of the tool runoff.

The maximum permissible deviation in mm is calculated by multiplying the tangent value by the length of the shorter leg. Any smaller angular tolerance required is indicated on the drawing.

Table 6 – General angular dimensions

Limit deviations in angle units for nominal dimension ranges of the shorter leg	up to 10 mm	> 10 mm to 50 mm	> 50 mm to 120 mm	> 120 mm to 400 mm	> 400 mm
Tolerance	± 1°	± 0° 30'	± 0° 20'	± 0° 10'	± 0° 5'
	Tangent values				
	0.0175	0.0087	0.0058	0.0029	0.0015
Tolerance class ^{a)}	a				
^{a)} According to DIN 2769:2021-12					

Table 7 - Angular dimensions for lubrication holes

Limit deviations in angle units for nominal dimension ranges of the shorter leg	up to 10 mm	> 10 mm to 50 mm	> 50 mm to 120 mm	> 120 mm to 400 mm	> 400 mm
Tolerance	± 1° 30'	± 1°	± 0° 30'	± 0° 15'	± 0° 10'
	Tangent values				
	0.0262	0.0175	0.0087	0.0044	0.0029
Tolerance class ^{a)}	b				
^{a)} According to DIN 2769:2021-12					

4.2 Shape and position

4.2.1 Basic specifications

General tolerances on form and position as per [DIN ISO 2768-2:1991-04](#) are applicable to machined parts. They also apply to individual dimensions or dimensions toleranced according to the ISO tolerance system. Table 8 gives an overview of the symbols for geometrical features according to [DIN EN ISO 1101:2017-09](#).

Table 8 – Overview of the symbols for geometrical features

Symbol	Designation	See section	Tolerance type
	Straightness	4.2.2.2	Tolerance on shape
	Flatness	4.2.2.2	
	Roundness	4.2.2.3	
	Parallelism	4.2.3.2	Position tolerance
	Perpendicularity	4.2.4.3	
	Symmetry	4.2.4.4	
	Coaxiality	4.2.4.5	
	Circular runout	4.2.4.6	
	Position	4.2.4.7	
	Line profile	-	Profile tolerance
	Total runout		Position tolerance
	Surface profile		Profile tolerance
	Cylindricity		Tolerance on shape
	Angularity		Position tolerance

4.2.2 Shape

4.2.2.1 General

Tolerances for the "form" specification according to [DIN EN ISO 1101](#) limit the extent to which an individual element is allowed to deviate from its geometrically ideal shape.

4.2.2.2 Straightness and flatness

The tolerances for the "form" specification with the features "straightness" and "flatness" can be found in Table 9.

Table 9 – Tolerance class for flatness and straightness (dimensions in mm)

Symbols		nominal dimension ranges	to 10	> 10 to 30	> 30 to 100	> 100 to 300	> 300 to 1000	> 1000 to 3000
Flatness	Straightness							
		Tolerance	0.02	0.05	0.1	0.2	0.3	0.4
		Tolerance class ^{a)}	H					

^{a)} According to [DIN ISO 2768-2:1991-04](#)

4.2.2.3 Roundness

The tolerances for the "form" specification with the feature "roundness" can be found in Table 10.

Table 10 – Tolerance class for roundness (dimensions in mm)

Symbol Roundness	Tolerance class acc. to DIN ISO 2768-2:1991-04	Roundness tolerance
	H	0.1

4.2.3 Position

4.2.3.1 General notes

As a rule, the specifications for orientation, location and runout according to [DIN EN ISO 1101](#) are included under the term "Position". The position tolerances limit the extent of deviation of the relative positions of two or more elements, one of which is, for functional reasons or for the purpose of clear definition, normally used as reference element for the tolerance indications. When necessary, more than one reference element can be specified.

The reference element shall fulfill a sufficient degree of accuracy and a shape tolerance shall be specified if necessary.

4.2.3.2 Parallelism

The tolerances for the "orientation" specification with the feature parallelism $//$ are limited by the tolerance assigned to the distance between the parallel lines or surfaces.

4.2.3.3 Perpendicularity

The tolerances for the "orientation" specification with the feature "perpendicularity" can be found in Table 11.

Table 11 – Perpendicularity tolerance (dimensions in mm)

Symbol Perpendicularity	nominal dimension ranges for the shorter angular leg	Up to 100	> 100 to 300	> 300 to 1000	> 1000 to 3000
	Tolerance	0.2	0.3	0.4	0.5
	Tolerance class ^{a)}	H			
^{a)} According to DIN ISO 2768-2:1991-04					

4.2.3.4 Symmetry

The tolerances for the "location" specification with the feature "symmetry" can be found in Table 12. The general tolerance for shapes which do not have a rotational symmetry also applies if one of the symmetrical shapes has a rotational symmetry and the other does not (e.g. universal joint-shaft heads and sockets).

Table 12 – Symmetry tolerance (dimensions in mm)

Symbol Symmetry	Tolerance class acc. to DIN ISO 2768-2:1991-04	Symmetry tolerance
	H	0.5

4.2.3.5 Coaxiality (for centerlines)

Tolerances for the "location" specification with the feature "coaxiality" are specified in Table 13.

Table 13 – Coaxiality tolerance (dimensions in mm)

Symbol Coaxiality	Coaxiality tolerance
	0.1

4.2.3.6 Circular runout

Tolerances for the "runout" specification with the feature "circular runout" (radial and axial runout) are specified in Table 14.

Table 14 – Runout tolerance (dimensions in mm)

Symbol Circular runout	Tolerance class acc. to DIN ISO 2768-2:1991-04	Runout tolerance
	H	0.1

4.2.3.7 Position

As a rule, tolerances for the "location" specification with the feature "position" are not specified. However, there is an SMS group specific exception for hole center distances and hole circle diameters according to Table 15, and for shaft and hub keyways according to Table 16.

The position tolerances according to Table 15 exclude the addition of the tolerances for hole center distances and hole circle diameters as well as the addition of all tolerances of hole center distances in a floating hole pattern. This means that the distances between the holes are theoretically exact coordinate dimensions without deviations, whose intersections define cylindrical tolerance zones in specified diameter values.

The tolerances for shaft and hub keyways according to Table 16 apply to toleranced keyway widths $\leq IT9$. The toleranced axis of the keyway must be between two parallel planes whose distance from each other is the specified tolerance in mm. The tolerance zone is symmetrical to the theoretically exact axis of the shaft or hub. In addition, the specified angle of another shaft/hub keyway is to be understood as a theoretically exact angular dimension without dimensional deviation.

Table 15 – Position tolerances for hole center distances and hole circle diameters (dimensions in mm)

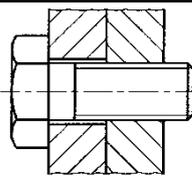
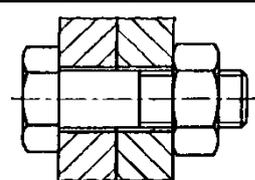
Thread diameter	M4	M5	M6	M8	M10	M12	M14	M16	M18	M20	M22	M24	M27	M30	M33	M36	M42	M48	M56	M64	M72	M80	M90	M100
Through-hole Series: medium ^{a)}	4.5	5.5	6.6	9	11	13.5	15.5	17.5	20	22	24	26	30	33	36	39	45	52	62	70	78	86	96	107
Through-hole Series: coarse ^{a)}	4.8	5.8	7	10	12	14.5	16.5	18.5	21	24	26	28	32	35	38	42	48	56	66	74	82	91	101	112
Position tolerance	Ø 0.25		Ø 0.3	Ø 0.5		Ø 0.75			Ø 1.0			Ø 1.5			Ø 2.0	Ø 3.0			Ø 3.5					
Symbol Position																								
	Example of threaded bore												Example of through-hole											

^{a)} Through-holes according to SN 480-2:2015-09

Table 16 – Position tolerance for shaft and hub keyways (dimensions in mm)

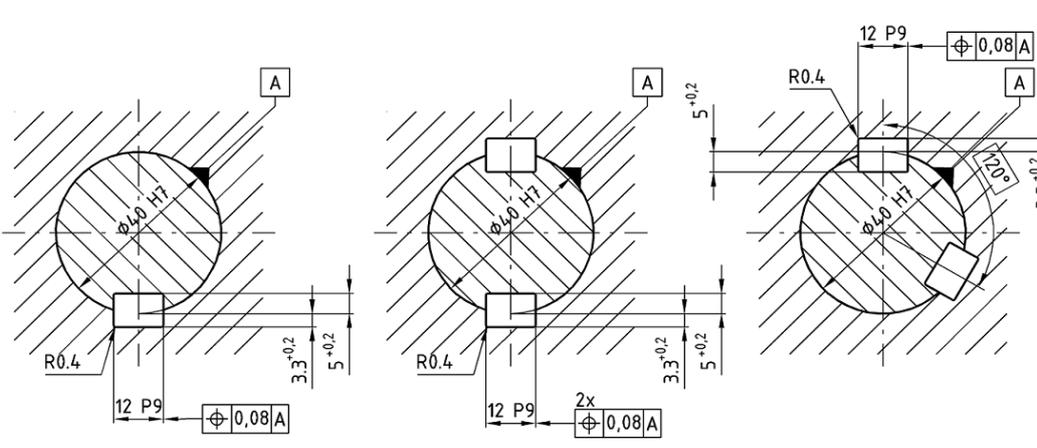
For shaft and hub diameters	over	10	12	17	22	30	38	44	50	58	65	75	85	95	110	130	150	170	200	230	260	290	330	380	440		
	to	12	17	22	30	38	44	50	58	65	75	85	95	110	130	150	170	200	230	260	290	330	380	440	500		
Position tolerance		0.06				0.08				0.1																	
Symbol Position																											
		Example of shaft and hub keyways																									

4.2.3.8 Hole drift in deep drilling

In full drilling with rotating workpiece, a drift of 1 mm for 1000 mm of drilling depth must not be exceeded. With a stationary workpiece and a rotating drill, the drift is twice as high.

5 Inspection

5.1 Basic specifications

All features produced during the manufacturing processes (dimensions, surface roughness etc.) shall be examined by the manufacturing workshop.

5.2 Requirements for measuring equipment

Every manufacturing shop shall make available sufficient measuring equipment for verification of the features produced. Measuring and inspection equipment shall be selected and used as appropriate for the respective measuring requirements and the measuring inaccuracies of the equipment shall be known. When necessary, proof shall be furnished of the fulfillment of the requirements concerning the control of measuring and test equipment as in [DIN EN ISO 9001:2015-11](#), Section 7.1.5: Resources for monitoring and measuring, and as in [DIN EN ISO 10012](#).

Geometrical tolerances shall be checked on calibrated 3-coordinate measuring machines. If the manufacturing shop has neither a 3-coordinate measuring machine nor comparable other measuring and testing equipment, SMS group reserves the right to demand inspection of the workpiece by scanning on a machine tool in unclamped condition. This inspection shall be performed on a machine whose accuracy is known and which was not involved in the production of the workpiece. The accuracy of the machine shall be proved when required. Machine errors shall be eliminated; if this is not possible, they shall be taken into account. Deviations from these regulations require the previous approval by the SMS group department of quality inspection.

5.3 Inspection documentation

When the criteria below apply, the manufacturing shop shall certify the results of its inspection in an inspection record stating the desired and the actual values.

- Dimensional tolerances with IT tolerance class \leq IT9;
- Dimensional tolerances without IT tolerance class as shown in the following:

Dimensions	up to	180 mm	with tolerance zone \leq 0.1 mm
Dimensions > 180	to	800 mm	with tolerance zone \leq 0.2 mm
Dimensions > 800	to	2000 mm	with tolerance zone \leq 0.4 mm
Dimensions > 2000	to	5000 mm	with tolerance zone \leq 0.8 mm
Dimensions	>	5000 mm	with tolerance zone \leq 1.0 mm
- Check dimensions with the inspection identifier according to [DIN 30-10](#);
- All geometrical tolerances indicated in the manufacturing documents;
- Angles, curves and radii smaller than the general tolerances specified in the present [SN 200-5](#);
- Surface roughness values $R_a \leq 0.8 \mu\text{m}$ according to [DIN ISO 1302:2002-06](#);
- Threads, except for metrical (normal) vee threads and pipe threads, with indication of testing method/means;
- Toothings, stating base tangent lengths, tooth form, tooth alignment, pitch;
- Surface treatments and coatings with indication of hardness and coat thickness, to be documented by test certificate 3.1 according to [DIN EN 10204](#) and/or [ISO 10474:2013-03](#);
- External condition, e.g. surface examination using dye penetrant or magnetic particle testing, see [SN 200-2](#);
- Internal condition using ultrasonic testing, see [SN 200-2](#).

5.4 Tolerances and limit deviations for linear sizes from 1 to 10,000 mm

5.4.1 Area of application

The following tolerances apply to all linear dimensions such as lengths, widths, heights, depths, diameters etc. For tolerancing, the linear dimensions from 1 to 10,000 mm are subdivided into ranges of nominal dimensions allocated to 12 different tolerance classes which shall be selected as required for the respective application.

The standard tolerances stated in Table 17 are assigned to the respective tolerance series and classes. The values are based on the reference temperature of 20 °C according to [DIN EN ISO 1:2016-12](#).

5.4.2 Designation of the tolerance series

The composition of the tolerance series designation is shown in Fig. 12.

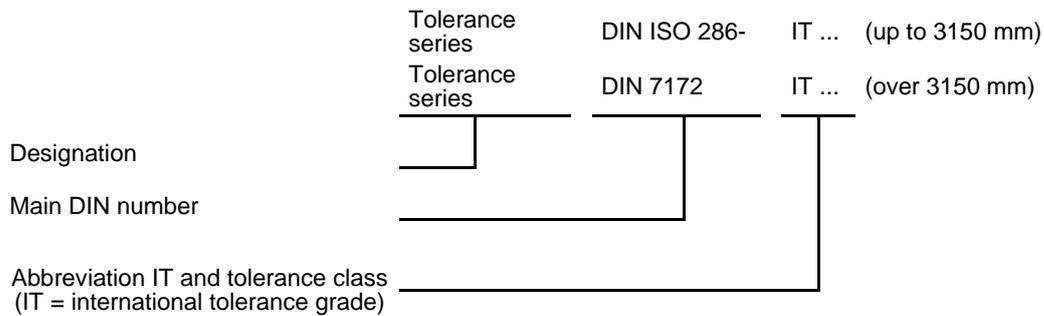

Fig. 12 - Designation of the tolerance series

5.4.3 Standard tolerances

The values of the tolerance zones for the standard tolerances grades IT5 to IT16 are listed in Table 17. The standard tolerances indicated for the nominal dimension ranges up to 3150 mm are specified according to [DIN EN ISO 286-2:2019-09](#), and the other standard tolerances for the nominal dimension ranges exceeding 3150 mm are specified according to [DIN 7172:1991-04](#).

Table 17 - Standard tolerances

Nominal dimension range mm	IT μm											
	5	6	7	8	9	10	11	12	13	14	15	16
From 1 up to 3	4	6	10	14	25	40	60	100	140	250	400	600
> 3 up to 6	5	8	12	18	30	48	75	120	180	300	480	750
> 6 to 10	6	9	15	22	36	58	90	150	220	360	580	900
> 10 to 18	8	11	18	27	43	70	110	180	270	430	700	1100
> 18 to 30	9	13	21	33	52	84	130	210	330	520	840	1300
> 30 to 50	11	16	25	39	62	100	160	250	390	620	1000	1600
> 50 to 80	13	19	30	46	74	120	190	300	460	740	1200	1900
> 80 to 120	15	22	35	54	87	140	220	350	540	870	1400	2200
> 120 to 180	18	25	40	63	100	160	250	400	630	1000	1600	2500
> 180 to 250	20	29	46	72	115	185	290	460	720	1150	1850	2900
> 250 to 315	23	32	52	81	130	210	320	520	810	1300	2100	3200
> 315 to 400	25	36	57	89	140	230	360	570	890	1400	2300	3600
> 400 to 500	27	40	63	97	155	250	400	630	970	1550	2500	4000
> 500 to 630	32	44	70	110	175	280	440	700	1100	1750	2800	4400
> 630 to 800	36	50	80	125	200	320	500	800	1250	2000	3200	5000
> 800 to 1000	40	56	90	140	230	360	560	900	1400	2300	3600	5600
> 1000 to 1250	47	66	105	165	260	420	660	1050	1650	2600	4200	6600
> 1250 to 1600	55	78	125	195	310	500	780	1250	1950	3100	5000	7800
> 1600 to 2000	65	92	150	230	370	600	920	1500	2300	3700	6000	9200
> 2000 to 2500	78	110	175	280	440	700	1100	1750	2800	4400	7000	11000
> 2500 to 3150	96	135	210	330	540	860	1350	2100	3300	5400	8600	13500
> 3150 to 4000	105	165	260	410	660	1050	1650	2600	4100	6600	10500	16500
> 4000 to 5000	130	200	320	500	800	1300	2000	3200	5000	8000	13000	20000
> 5000 to 6300	160	250	400	620	980	1600	2500	4000	6200	9800	16000	25000
> 6300 to 8000	195	310	490	760	1200	1950	3100	4900	7600	12000	19500	31000
> 8000 to 10000	240	380	600	940	1500	2400	3800	6000	9400	15000	24000	38000

5.4.4 Limit deviations for external and internal dimensions in the nominal dimension range up to 3150 mm

The tolerance zones for the nominal dimension range up to 3150 mm according to [DIN EN ISO 286-2:2019-09](#) are an SMS group selection and specified in Table 18 for external dimensions and in Table 19 for internal dimensions.

Table 18 – Tolerance zones for external dimensions up to 3150 mm

Nominal dim. range mm	Limit deviations in µm														
	e7	e8	e9	f7	g6	h6	h9	h11	j6/js6 a)	k6	m6	n6	p6	r6	s6
> 1 to 3	-14 -24	-14 -28	-14 -39	-6 -16	-2 -8	0 -6	0 -25	0 -60	+4 -2	+6 0	+8 +2	+10 +4	+12 +6	+16 +10	+20 +14
> 3 to 6	-20 -32	-20 -38	-20 -50	-10 -22	-4 -12	0 -8	0 -30	0 -75	+6 -2	+9 +1	+12 +4	+16 +8	+20 +12	+23 +15	+27 +19
> 6 to 10	-25 -40	-25 -47	-25 -61	-13 -28	-5 -14	0 -9	0 -36	0 -90	+7 -2	+10 +1	+15 +6	+19 +10	+24 +15	+28 +19	+32 +23
> 10 to 18	-32 -50	-32 -59	-32 -75	-16 -34	-6 -17	0 -11	0 -43	0 -110	+8 -3	+12 +1	+18 +7	+23 +12	+29 +18	+34 +23	+39 +28
> 18 to 30	-40 -61	-40 -73	-40 -92	-20 -41	-7 -20	0 -13	0 -52	0 -130	+9 -4	+15 +2	+21 +8	+28 +15	+35 +22	+41 +28	+48 +35
> 30 to 50	-50 -75	-50 -89	-50 -112	-25 -50	-9 -25	0 -16	0 -62	0 -160	+11 -5	+18 +2	+25 +9	+33 +17	+42 +26	+50 +34	+59 +43
> 50 to 65	-60 -90	-60 -106	-60 -134	-30 -60	-10 -29	0 -19	0 -74	0 -190	+12 -7	+21 +2	+30 +11	+39 +20	+51 +32	+60 +41	+72 +53
> 65 to 80														+62 +43	+78 +59
> 80 to 100	-72 -107	-72 -126	-72 -159	-36 -71	-12 -34	0 -22	0 -87	0 -220	+13 -9	+25 +3	+35 +13	+45 +23	+59 +37	+73 +51	+93 +71
> 100 to 120														+76 +54	+101 +79
> 120 to 140														+88 +63	+117 +92
> 140 to 160	-85 -125	-85 -148	-85 -185	-43 -83	-14 -39	0 -25	0 -100	0 -250	+14 -11	+28 +3	+40 +15	+52 +27	+68 +43	+90 +65	+125 +100
> 160 to 180														+93 +68	+133 +108
> 180 to 200														+106 +77	+151 +122
> 200 to 225	-100 -146	-100 -172	-100 -215	-50 -96	-15 -44	0 -29	0 -115	0 -290	+16 -13	+33 +4	+46 +17	+60 +31	+79 +50	+109 +80	+159 +130
> 225 to 250														+113 +84	+169 +140
> 250 to 280	-110 -162	-110 -191	-110 -240	-56 -108	-17 -49	0 -32	0 -130	0 -320	+16 -16	+36 +4	+52 +20	+66 +34	+88 +56	+126 +94	+190 +158
> 280 to 315														+130 +98	+202 +170
> 315 to 355	-125 -182	-125 -214	-125 -265	-62 -119	-18 -54	0 -36	0 -140	0 -360	+18 -18	+40 +4	+57 +21	+73 +37	+98 +62	+144 +108	+226 +190
> 355 to 400														+150 +114	+244 +208
> 400 to 450	-135 -198	-135 -232	-135 -290	-68 -131	-20 -60	0 -40	0 -155	0 -400	+20 -20	+45 +5	+63 +23	+80 +40	+108 +68	+166 +126	+272 +232
> 450 bis 500														+172 +132	+292 +252
> 500 to 560	-145 -215	-145 -255	-145 -320	-76 -146	-22 -66	0 -44	0 -175	0 -440	+22 -22	+44 0	+70 +26	+88 +44	+122 +78	+194 +150	+324 +280
> 560 to 630														+199 +155	+354 +310
> 630 to 710	-160 -240	-160 -285	-160 -360	-80 -160	-24 -74	0 -50	0 -200	0 -500	+25 -25	+50 0	+80 +30	+100 +50	+138 +88	+225 +175	+390 +340
> 710 to 800														+235 +185	+430 +380
> 800 to 900	-170 -260	-170 -310	-170 -400	-86 -176	-26 -82	0 -56	0 -230	0 -560	+28 -28	+56 0	+90 +34	+112 +56	+156 +100	+266 +210	+486 +430
> 900 to 1000														+276 +220	+526 +470
> 1000 to 1120	-195 -300	-195 -360	-195 -455	-98 -203	-28 -94	0 -66	0 -260	0 -660	+33 -33	+66 0	+106 +40	+132 +66	+186 +120	+316 +250	+586 +520
> 1120 Up to 1250														+326 +260	+646 +580
> 1250 Up to 1400	-220 -345	-220 -415	-220 -530	-110 -235	-30 -108	0 -78	0 -310	0 -780	+39 -39	+78 0	+126 +48	+156 +78	+218 +140	+378 +300	+718 +640
> 1400 Up to 1600														+408 +330	+798 +720
> 1600 Up to 1800	-240 -390	-240 -470	-240 -610	-120 -270	-32 -124	0 -92	0 -370	0 -920	+46 -46	+92 0	+150 +58	+184 +92	+262 +170	+462 +370	+912 +820
> 1800 Up to 2000														+492 +400	+1012 +920
> 2000 to 2240	-260 -435	-260 -540	-260 -700	-130 -305	-34 -144	0 -110	0 -440	0 -1100	+55 -55	+110 0	+178 +68	+220 +110	+305 +195	+550 +440	+1110 +1000
> 2240 Up to 2500														+570 +460	+1210 +1100
> 2500 to 2800	-290 -500	-290 -620	-290 -830	-145 -355	-38 -173	0 -135	0 -540	0 -1350	+67,5 -67,5	+135 0	+211 +76	+270 +135	+375 +240	+685 +550	+1385 +1250
> 2800 to 3150														+715 +580	+1535 +1400

a) js6 applies to a nominal dimension range exceeding 500

Table 19– Tolerance zones for internal dimensions up to 3150 mm

Nominal dimension range	Limit deviations in µm															
	D7	D10	E9	F7	F8	G7	G8	H7	H8	H9	H12	H13	J7/JS7 ^{a)}	K7	M7	P9
> 1 to 3	+ 30 + 20	+ 60 + 20	+ 39 + 14	+ 16 + 6	+ 20 + 6	+ 12 + 2	+ 16 + 2	+ 10 0	+ 14 0	+ 25 0	+ 100 0	+ 140 0	+ 4 - 6	0 - 10	- 2 - 12	- 6 - 31
> 3 to 6	+ 42 + 30	+ 78 + 30	+ 50 + 20	+ 22 + 10	+ 28 + 10	+ 16 + 4	+ 22 + 4	+ 12 0	+ 18 0	+ 30 0	+ 120 0	+ 180 0	+ 6 - 6	+ 3 - 9	0 - 12	- 12 - 42
> 6 to 10	+ 55 + 40	+ 98 + 40	+ 61 + 25	+ 28 + 13	+ 35 + 13	+ 20 + 5	+ 27 + 5	+ 15 0	+ 22 0	+ 36 0	+ 150 0	+ 220 0	+ 8 - 7	+ 5 - 10	0 - 15	- 15 - 51
> 10 to 18	+ 68 + 50	+ 120 + 50	+ 75 + 32	+ 34 + 16	+ 43 + 16	+ 24 + 6	+ 33 + 6	+ 18 0	+ 27 0	+ 43 0	+ 180 0	+ 270 0	+ 10 - 8	+ 6 - 12	0 - 18	- 18 - 61
> 18 to 30	+ 86 + 65	+ 149 + 65	+ 92 + 40	+ 41 + 20	+ 53 + 20	+ 28 + 7	+ 40 + 7	+ 21 0	+ 33 0	+ 52 0	+ 210 0	+ 330 0	+ 12 - 9	+ 6 - 15	0 - 21	- 22 - 74
> 30 to 50	+ 105 + 80	+ 180 + 80	+ 112 + 50	+ 50 + 25	+ 64 + 25	+ 34 + 9	+ 48 + 9	+ 25 0	+ 39 0	+ 62 0	+ 250 0	+ 390 0	+ 14 - 11	+ 7 - 18	0 - 25	- 26 - 88
> 50 to 65	+ 130	+ 220	+ 134	+ 60	+ 76	+ 40	+ 56	+ 30	+ 46	+ 74	+ 300	+ 460	+ 18	+ 9	0	- 32
> 65 to 80	+ 100	+ 100	+ 60	+ 30	+ 30	+ 10	+ 10	0	0	0	0	0	- 12	- 21	- 30	- 106
> 80 to 100	+ 155	+ 260	+ 159	+ 71	+ 90	+ 47	+ 66	+ 35	+ 54	+ 87	+ 350	+ 540	+ 22	+ 10	0	- 37
> 100 to 120	+ 120	+ 120	+ 72	+ 36	+ 36	+ 12	+ 12	0	0	0	0	0	- 13	- 25	- 35	- 124
> 120 to 140																
> 140 to 160	+ 185 + 145	+ 305 + 145	+ 185 + 85	+ 83 + 43	+ 106 + 43	+ 54 + 14	+ 77 + 14	+ 40 0	+ 63 0	+ 100 0	+ 400 0	+ 630 0	+ 26 - 14	+ 12 - 28	0 - 40	- 43 - 143
> 160 to 180																
> 180 to 200																
> 200 to 225	+ 216 + 170	+ 355 + 170	+ 215 + 100	+ 96 + 50	+ 122 + 50	+ 61 + 15	+ 87 + 15	+ 46 0	+ 72 0	+ 115 0	+ 460 0	+ 720 0	+ 30 - 16	+ 13 - 33	0 - 46	- 50 - 165
> 225 to 250																
> 250 to 280	+ 242	+ 400	+ 240	+ 108	+ 137	+ 69	+ 98	+ 52	+ 81	+ 130	+ 520	+ 810	+ 36	+ 16	0	- 56
> 280 to 315	+ 190	+ 190	+ 110	+ 56	+ 56	+ 17	+ 17	0	0	0	0	0	- 16	- 36	- 52	- 186
> 315 to 355	+ 267	+ 440	+ 265	+ 119	+ 151	+ 75	+ 107	+ 57	+ 89	+ 140	+ 570	+ 890	+ 39	+ 17	0	- 62
> 355 to 400	+ 210	+ 210	+ 125	+ 62	+ 62	+ 18	+ 18	0	0	0	0	0	- 18	- 40	- 57	- 202
> 400 to 450	+ 293	+ 480	+ 290	+ 131	+ 165	+ 83	+ 117	+ 63	+ 97	+ 155	+ 630	+ 970	+ 43	+ 18	0	- 68
> 450 to 500	+ 230	+ 230	+ 135	+ 68	+ 68	+ 20	+ 20	0	0	0	0	0	- 20	- 45	- 63	- 223
> 500 to 560	+ 330	+ 540	+ 320	+ 146	+ 186	+ 92	+ 132	+ 70	+ 110	+ 175	+ 700	+ 1100	+ 35	0	- 26	- 78
> 560 to 630	+ 260	+ 260	+ 145	+ 76	+ 76	+ 22	+ 22	0	0	0	0	0	- 35	- 70	- 96	- 253
> 630 to 710	+ 370	+ 610	+ 360	+ 160	+ 205	+ 104	+ 149	+ 80	+ 125	+ 200	+ 800	+ 1250	+ 40	0	- 30	- 88
> 710 to 800	+ 290	+ 290	+ 160	+ 80	+ 80	+ 24	+ 24	0	0	0	0	0	- 40	- 80	- 110	- 288
> 800 to 900	+ 410	+ 680	+ 400	+ 176	+ 226	+ 116	+ 166	+ 90	+ 140	+ 230	+ 900	+ 1400	+ 45	0	- 34	- 100
> 900 to 1000	+ 320	+ 320	+ 170	+ 86	+ 86	+ 26	+ 26	0	0	0	0	0	- 45	- 90	- 124	- 330
> 1000 to 1120	+ 455	+ 770	+ 455	+ 203	+ 263	+ 133	+ 193	+ 105	+ 165	+ 260	+ 1050	+ 1650	+ 52,5	0	- 40	- 120
> 1120 to 1250	+ 350	+ 350	+ 195	+ 98	+ 98	+ 28	+ 28	0	0	0	0	0	- 52,5	- 105	- 145	- 380
> 1250 to 1400	+ 515	+ 890	+ 530	+ 235	+ 305	+ 155	+ 225	+ 125	+ 195	+ 310	+ 1250	+ 1950	+ 62,5	0	- 48	- 140
> 1400 to 1600	+ 390	+ 390	+ 220	+ 110	+ 110	+ 30	+ 30	0	0	0	0	0	- 62,5	- 125	- 173	- 450
> 1600 to 1800	+ 580	+ 1030	+ 610	+ 270	+ 350	+ 182	+ 262	+ 150	+ 230	+ 370	+ 1500	+ 2300	+ 75	0	- 58	- 170
> 1800 to 2000	+ 430	+ 430	+ 240	+ 120	+ 120	+ 32	+ 32	0	0	0	0	0	- 75	- 150	- 208	- 540
> 2000 to 2240	+ 655	+ 1180	+ 700	+ 305	+ 410	+ 209	+ 314	+ 175	+ 280	+ 440	+ 1750	+ 2800	+ 87,5	0	- 68	- 195
> 2240 to 2500	+ 480	+ 480	+ 260	+ 130	+ 130	+ 34	+ 34	0	0	0	0	0	- 87,5	- 175	- 243	- 635
> 2500 to 2800	+ 730	+ 1380	+ 830	+ 355	+ 475	+ 248	+ 368	+ 210	+ 330	+ 540	+ 2100	+ 3300	+ 105	0	- 76	- 240
> 2800 to 3150	+ 520	+ 520	+ 290	+ 145	+ 145	+ 38	+ 38	0	0	0	0	0	- 105	- 210	- 286	- 780

^{a)} JS7 applies over nominal dimension range 500

5.4.5 Limit deviations for external and internal dimensions in the nominal dimension range from 3150 mm to 10000 mm

The tolerance zones for the nominal dimension range from 3150 mm to 10,000 mm according to [DIN 7172:1991-04](#) are a selection of SMS group and are specified in Table 20 for external dimensions and in Table 21 for internal dimensions.

Table 20 – Tolerance zones for external dimensions from 3150 mm to 10000 mm

Nominal dimension range mm	Limit deviations in µm												
	e7	e8	e9	f7	g6	h6	h9	h11	js6	k6	m6	n6	p6
> 3150 to 4000	- 320 - 580	- 320 - 730	- 320 - 980	- 160 - 420	- 40 - 205	0 - 165	0 - 660	0 - 1650	+ 83 - 83	+ 165 0	+ 263 + 98	+ 330 + 165	+ 455 + 290
> 4000 to 5000	- 350 - 670	- 350 - 850	- 350 - 1150	- 175 - 495	- 43 - 243	0 - 200	0 - 800	0 - 2000	+ 100 - 100	+ 200 0	+ 320 + 120	+ 400 + 200	+ 560 + 360
> 5000 to 6300	- 380 - 780	- 380 - 1000	- 380 - 1360	- 190 - 590	- 47 - 297	0 - 250	0 - 980	0 - 2500	+ 125 - 125	+ 250 0	+ 395 + 145	+ 500 + 250	+ 690 + 440
> 6300 to 8000	- 420 - 910	- 420 - 1180	- 420 - 1620	- 210 - 700	- 51 - 361	0 - 310	0 - 1200	0 - 3100	+ 155 - 155	+ 310 0	+ 495 + 185	+ 610 + 300	+ 850 + 540
> 8000 to 10000	- 460 - 1060	- 460 - 1400	- 460 - 1960	- 230 - 830	- 55 - 435	0 - 380	0 - 1500	0 - 3800	+ 190 - 190	+ 380 0	+ 610 + 230	+ 760 + 380	+ 1060 + 680

Table 21 – Tolerance zones for internal dimensions from 3150 mm to 10000 mm

Nominal dimension range mm	Limit deviations in µm													
	D7	D10	E9	F7	F8	G7	H7	H8	H9	H12	H13	JS7	K7	M7
> 3150 to 4000	+ 840 + 580	+ 1630 + 580	+ 980 + 320	+ 420 + 160	+ 570 + 160	+ 300 + 40	+ 260 0	+ 410 0	+ 660 0	+ 2600 0	+ 4100 0	+ 130 - 130	0 - 260	- 98 - 358
> 4000 to 5000	+ 960 + 640	+ 1940 + 640	+ 1150 + 350	+ 495 + 175	+ 675 + 175	+ 363 + 43	+ 320 0	+ 500 0	+ 800 0	+ 3200 0	+ 5000 0	+ 160 - 160	0 - 320	- 120 - 440
> 5000 to 6300	+ 1120 + 720	+ 2320 + 720	+ 1360 + 380	+ 590 + 190	+ 810 + 190	+ 447 + 47	+ 400 0	+ 620 0	+ 980 0	+ 4000 0	+ 6200 0	+ 200 - 200	0 - 400	- 145 - 545
> 6300 to 8000	+ 1290 + 800	+ 2750 + 800	+ 1620 + 420	+ 700 + 210	+ 970 + 210	+ 541 + 51	+ 490 0	+ 760 0	+ 1200 0	+ 4900 0	+ 7600 0	+ 245 - 245	0 - 490	- 185 - 675
> 8000 to 10000	+ 1480 + 880	+ 3280 + 880	+ 1960 + 460	+ 830 + 230	+ 1170 + 230	+ 655 + 55	+ 600 0	+ 940 0	+ 1500 0	+ 6000 0	+ 9400 0	+ 300 - 300	0 - 600	- 230 - 830

Annex A (informative) Representation on drawings

A.1 Basic specifications

The surface texture is indicated in drawings according to [DIN EN ISO 1302:2002-06](#). The tables A.1 and A.2 show comparisons of the symbols according to [DIN EN ISO 1302:2002-06](#) and [DIN ISO 1302:1993-12](#) (withdrawn). In the drawings, SMS group indicates the centerline average roughness R_a as preferred measured variable.

A.2 Symbols

A.2.1 Positions of the surface indications at the symbol

Table A.1 shows the comparison of the symbols and the explanation of the surface indications according to [DIN EN ISO 1302:2002-06](#) and [DIN ISO 1302:1993-12](#) (withdrawn).

Table A.1 – Surface indications

Symbol according to DIN EN ISO 1302:2002-06	Meaning	Symbol according to DIN ISO 1302:1993-12 (withdrawn)	Meaning	Explanation
	a = roughness value R_a in μm		a = roughness value R_a in μm	SMS group Standard indication
	b = surface texture requirements		b = manufacturing process, surface treatment	Indications shall be made only if indispensable for functional reasons
	c = manufacturing process		c = reference length	
	d = surface grooves and direction		d = groove direction	
	e = machining allowance		e = machining allowance	
	f = other measured roughness variables e.g. $R_{z1\text{max}}$, R_{amax}		f = other measured roughness variables e.g. R_z , R_{max}	

A.2.2 Surface texture indication at the symbol

Symbols for surface texture indication are shown in table A.2. The use of summarising symbols shall be avoided.

Table A.2 – Surface texture

Symbol according to DIN EN ISO 1302:2002-06	Symbol according to DIN ISO 1302:1993-12 (withdrawn)	Meaning
✓	✓	Basic symbol. Additional information is required for clear definition.
$\sqrt{Ra\ 3,2}$	$\frac{3,2}{\checkmark}$	The surface is allowed to be produced by any manufacturing process within the specified centerline average roughness $R_a \leq 3.2\ \mu\text{m}$.
		The surface shall be produced by a metal-cutting process (machining); no specification of centerline average roughness.
$\sqrt{Ra\ 3,2}$ with triangle inside	$\frac{3,2}{\checkmark}$ with triangle inside	The surface shall be produced by a metal-cutting (machining) process within the specified centerline average roughness $R_a \leq 3.2\ \mu\text{m}$.
		Extended graphical symbol: Surface on which metal-cutting working is not allowed. This symbol can also be used on drawings intended for a particular work step to show that a surface shall be left in the condition produced in the preceding work step no matter whether this condition was produced by machining or in a different way.

A.2.3 Symbols for indication of the surface grooves

The surface grooves and the groove direction produced by the machining process (e.g. traces left by tools) are shown in table A.3 in compliance with [DIN EN ISO 1302:2002-06](#).

Table A.3 – Surface grooves

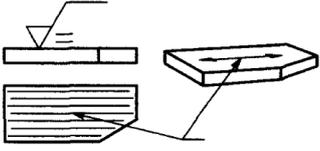
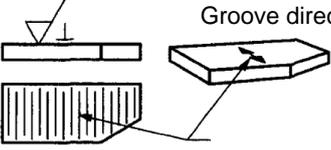
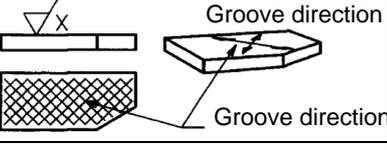
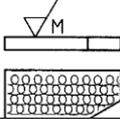
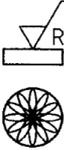
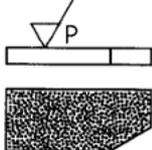
Symbol	Explanation	Graphical representation
=	Parallel to the plane of projection of the view in which the symbol is used	
⊥	Perpendicular to the plane of projection of the view in which the symbol is used	
X	Crossed in two oblique directions relative to the plane of projection of the view in which the symbol is used	
M	Multidirectional	
C	Approximately centric relative to the center of the surface to which the symbol refers	
R	Approximately radial relative to the center of the surface to which the symbol refers	
P	Ungrooved surface, unlevelled or troughed	

Annex B (informative) Surface roughness values

Table B.1 gives an overview of the surface roughness values. The values in shaded spaces are SMS group standard and shall be used with preference.

Table B.1 – Surface roughness values

Selection series and comparison			
DIN ISO 1302:2002-06			
Ra μm	Ra μinch	Roughness class	Rz μm
50	2000	N 12	160
25	1000	N 11	100
12.5	500	N 10	63
6.3	250	N 9	40
3.2	125	N 8	25
1.6	63	N 7	12.5
0.8	32	N 6	6.3
0.4	16	N 5	2.5
0.2	8	N 4	1.6
0.1	4	N 3	1

Amendments

Amendments made in comparison with [SN 200-5:2016-05](#):

Editorial revisions	New introduction Updating of the normative references Section 3 revised and extended
Section 3.6	Table 2, End faces for bolt head and nut supports: "on rolled plate" replaced with "on cold-drawn material"
Section 3.7	Addition of surface treatment
Section 4	General tolerances adapted to DIN 2769
Section 4.2	Information on the symbols adapted to DIN EN ISO 1101:2017-09
Section 4.2.3.7	Table 15, data of the "coarse" series complemented with data from SN 480-2:2015-09 , addition of table 16
Section 5.3	"Tolerance range" changed to "tolerance zone", addition of check dimensions according to DIN 30-10 , test certificate 3.1 according to DIN EN 10204 and/or ISO 10474
Section 5.4	Documentation for pressure testing removed; Table 18, correction of the table value in column j6/js6 for the nominal dimension range of 2500mm to 3150mm Table 19, J7/JS7: table values for 1000mm to 1250mm, 1250mm to 1600mm and 2000mm to 2500mm corrected
Annex A	Contents of the old Annex A (information on the definition of geometrical tolerance zones relevant for design, thus included in SN 100) partly deleted or added to the normative part of the standard (e.g. free choice of tool, section 3.3)

Previous editions

SN 200:1971-09, 1975-11, 1978-01, 1981-01, 1985-01, 1992-03, 1996-03, 1999-09, 2003-09, 2007-02, 2010-09
SN 200-5:2016-05