

No guarantee can be given in respect of this translation
In all cases the latest German-language version
of this standard shall be taken as authoritative

This copy will not be updated in case of changes!

1 Scope

The hoses specified in this standard are used in high-pressure hydraulic systems carrying fluids on mineral-oil basis and water-glycol emulsions. The hoses are also used for systems carrying light fuel oil, lubricating oil, water and air; for air systems up to max. 5 MPa (50 bar). The hoses are suitable for the temperature range from -40 °C to +100 °C. The hoses specified in this standard shall be used with preference. They are interchangeable with the corresponding types of AEROQUIP, DUNLOP and ARGUS.

2 Examples of designation (for further combinations, see page 2, item 4)

Type A (from DN 6 to DN 40)
for welding cone couplings

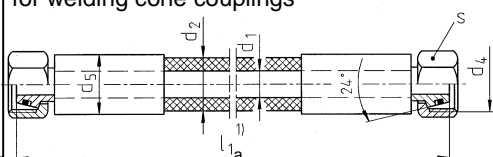

Designation of a complete high-pressure hose (4H), type A, of nominal dia. DN 16 and a length of 1000 mm:

Hoseline SN 756 - 4HA 16 x 1000

Type C (from DN 12 to DN 50)
for SAE flanged connection 6000 psi

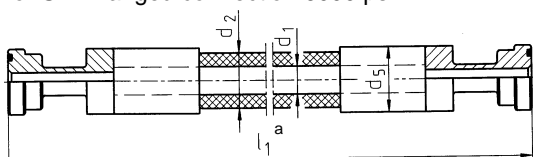

Designation of a complete high-pressure hose (4H), type C, of nominal dia. DN 20 and a length of 1000 mm:

Hoseline SN 756 - 4HC 20 x 1000

Type E (from DN 12 to DN 50)
for SAE flanged connection 6000 psi

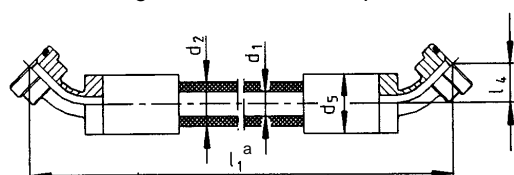

Designation of a complete high-pressure hose (4SH), type E, of nominal dia. DN 32 and a length of 1000 mm:

Hoseline SN 756 - 4SHE 32 x 1000

Type B (from DN 6 to DN 8)
for solderless pipe couplings

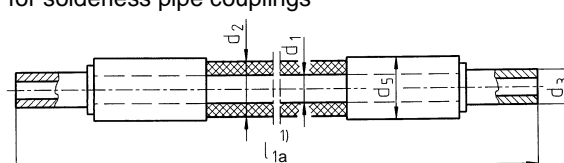

Designation of a complete high-pressure hose (H), type B, of nominal dia. DN 6 for outside pipe diameter $d_3 = 8$ mm and a length of 1000 mm:

Hoseline SN 756 - HB 6 x 8 x 1000

Type D (from DN 12 to DN 50)
for SAE flanged connection 6000 psi

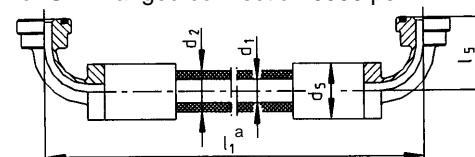

Designation of a complete high-pressure hose (4SH), type D, of nominal dia. DN 25 and a length of 1000 mm:

Hoseline SN 756 - 4SHD 25 x 1000

Type F (from DN 6 to DN 32)
for welding cone couplings

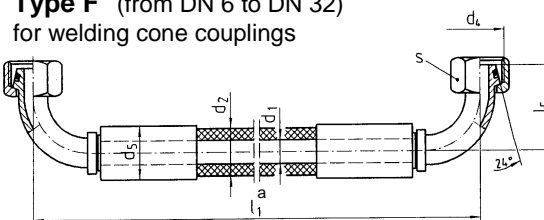

Designation of a complete high-pressure hose (H), type F, of nominal dia. DN 8 and a length of 1000 mm:

Hoseline SN 756 - HF 8 x 1000

Type G (from DN 6 to DN 32)
for welding cone couplings

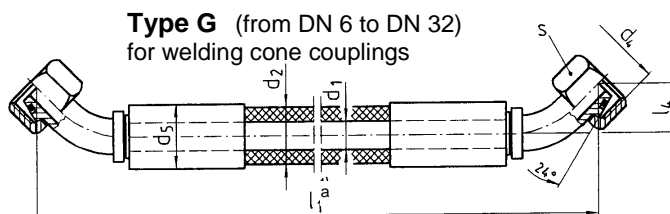

Designation of a complete high-pressure hose (4H), type G, of nominal diameter DN 12 and a length of 1000 mm:

Hoseline SN 756 - 4HG 12 x 1000

^a The length shall be specified as required for the purpose, but with due regard to the standard lengths.

3 Specification in bill of materials

When hoses are **subsequently** equipped with heat protection, the heat protection hose (HSS) and the pertaining hose clamp shall be specified in the bill of materials with reference to the respective hose line.
The hoses DN 40 and DN 50 and all hoses with special-steel fittings cannot be crimped at SMS Siemag and are hence ordered as complete units.

4 Overview of combinations of hose fittings

The following standardised combinations shall be used with preference at SMS Siemag.
The shaded boxes show hoses that have identical fittings at both hose ends.

Table 1 – Combinations of hose line fittings

Type	Fitting 2							
	A	B	C	D	E	F	G	
Fitting 1	A	HA 6 and 8 4 HA 12 to 20 4SHA 25 to 40	HAB 6x6 to 8 -	- 4 HAC 12 to 20 4SHAC 25 to 40	- 4 HAD 12 to 20 4SHAD 25 to 40	- 4 HAE 12 to 20 4SHAE 25 to 40	HAF 6 and 8 4 HAF 12 to 20 4SHAF 25 and 32	HAG 6 and 8 4 HAG 12 to 20 4SHAG 25 and 32
	B		HB 6x6 to 8 -	- -	- -	- -	- -	- -
	C			4 HC 12 to 20 4SHC 25 to 40 6SPC 50	4 HCD 12 to 20 4SHCD 25 to 40 6SPCD 50	4 HCE 12 to 20 4SHCE 25 to 40 6SPCE 50	4 HCF 12 to 20 4SHCF 25 and 32 -	4 HCG 12 to 20 4SHCG 25 and 32 -
	D				4 HD 12 to 20 4SHD 25 to 40 6SPD 50	4 HDE 12 to 20 4SHDE 25 to 40 6SPDE 50	4 HDF 12 to 20 4SHDF 25 and 32 -	4 HDG 12 to 20 4SHDG 25 and 32 -
	E					4 HE 12 to 20 4SHE 25 to 40 6SPE 50	4 HEF 12 to 20 4SHEF 25 and 32 -	4 HEG 12 to 20 4SHEG 25 and 32 -
	F						HF 6 and 8 4 HF 12 to 20 4SHF 25 and 32	HFG 6 and 8 4 HFG 12 to 20 4SHFG 25 and 32
	G							HG 6 and 8 4 HG 12 to 20 4SHG 25 and 32

5 Technical data of hoses

For types A, B, F and G (24° cone coupling connection)

Table 2 – Types A, B, F and G

	DN	Pipe connection	d ₁ min.	d ₂ max.	d ₃	d ₄	d ₅	l ₄ - 8	l ₅ - 8	Bending radius r _{min}	s	Operating pressure bar	
												dynam.	static ^a
H	6	6	6,2	15,7	6	-	21	-	-	100	-	400	600
		8			8	-		-	-				
		10			10	M18 x 1,5		22	39		22		
	8	12	7,7	17,3	12	M20 x 1,5	22	24	39	115	24	350	560
4H	12	16	12,3	25,9	-	M24 x 1,5	28	25	50	230	30	415	660
	16	20	15,5	29,0	-	M30 x 2	32	30	55	250	36	350	500
	20 (19)	25	18,6	33,0	-	M36 x 2	37	34	63	300	46	350	500
4SH	25	30	25,0	39,9	-	M42 x 2	48	41	80	340	50	380	550
	32 (31)	38	31,4	47,1	-	M52 x 2	57	52	98	460	60	350	500
	40 (38)	-	37,7	55,1	-	M68 x 2	62	-	-	560	80	290	420

^a Static operating pressure may be used only for power fluids with high water content which are predominantly exposed to static loads.

For types C, D and E (with SAE connection)

Table 3 – Types C, D and E

	DN	SAE connection 6000 psi	d ₁ min.	d ₂ max.	d ₅	l ₄ - 8	l ₅ - 8	Bending radius r _{min}	Operating pressure bar	
									dynamic	static ^a
4H	12	1/2 "	12,3	25,9	29	25	58	230	415	660
	16		15,5	29,0	32	26	58	250	350	500
	20 (19)	3/4 "	18,6	33,0	38	30	66	300	350	500
4SH	25	1 "	25,0	39,9	49	39	78	340	380	550
	32 (31)	1 1/2 "	31,4	47,1	57	53	105	460	350	500
	40 (38)		37,7	55,1	62	58	115	560	290	420
6SP	50 (51)	2 "	51,4	71,7	87,6	69	150	630	420	670

^a Static operating pressure may be used only for power fluids with high water content which are predominantly exposed to static loads.

6 Further ordering specifications

6.1 Angular position

The angular positions of hoselines with elbow fittings at both ends (types D to G) are indicated as described below. No indication is required for an angle of 0°. The tolerance on the angular position is ± 5°.

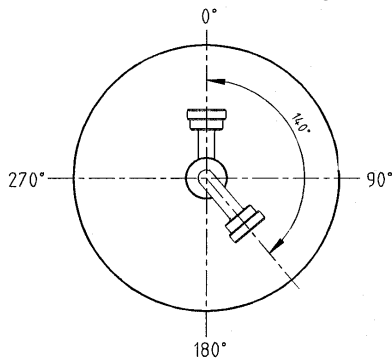

Look along the hoseline with the fitting at the far end pointing upward.

Specify the angle between the far-end fitting and the near-end fitting in clockwise direction.

Hoselines at an angular position of 140° shall be specified as follows:

Hoseline SN 756 - 4SHD 32 x 1250 turned by 140°

6.2 Heat protection

Hoselines with heat protection shall be specified as follows:

Hoseline SN 756 – 4 SHD 32 x 1250 + HSS

Table 4 – Assignment of nominal hoseline diameter (DN) to heat protection hose (HSS) and hoseline clamp

DN	Heat protection hose SN 775-	Hose clamp DIN 3017-1W4	Specification required for subsequent providing of a finished hoseline with heat protection hose
6	HSS 22	A-16-27x9	HSS 30
8	HSS 30	A-25-40x9	HSS 35
12	HSS 35	A-30-45x9	HSS 40
16	HSS 40	A-30-45x9	HSS 50
20 (19)	HSS 50	A-40-60x9	HSS 60
25	HSS 60	A-40-60x9	HSS 70
32 (31)	HSS 70	A-50-70x9	HSS 80
40 (38)	HSS 70	A-60-80x9	HSS 100
50 (51)	HSS 90	A-80-100x9	HSS 100

Lasting protection at high temperatures can be achieved only with sufficient air volume between the line to be protected and the heat protection hose (HSS). This has been taken into account in the assignment of the heat protection hoses to the hoselines (see Table 4).

The heat protection hose is **always** fastened on the fitting with **one** hose clamp according to DIN 3017-1.

The technical data of the heat protection hose (HSS) are given in SN 775 and shall be complied with when alternative products are used.

6.3 FPM seals

Hoselines with O-rings made of FPM (Viton) are specified as follows (only types A, F and G and their combinations):

Hoseline SN 756 – 4 SHA 32 x 1250 + FPM

6.4 Special-steel fittings

Hoselines with hose fittings in special steel (E) shall be specified as follows:

Hoseline SN 756 – E - 4 SHD 32 x 1250

Note: Hoselines with special-steel fittings are more expensive and have longer terms of delivery than hoselines with standard fittings in electrogalvanised steel.

7 Standard hoseline lengths

Table 5 – Standard hoseline lengths

DN	l ₁													
6	300	400	500	600	800	1000	1250	1400	1600	1800	2000	2500	3000	4000
8														
12														
16														
20 (19)														
25														
32 (31)														
40 (38)														
50 (51)														

8 Permissible length deviations

Table 6 – Permissible length deviations according to DIN 20066

l ₁	Up to 630	above 630 to 1250	above 1250 to 2500	above 2500 to 8000	above 8000
≤ DN25	+7 -3	+12 -4	+20 -6	+1,5% -0,5%	+3% -1%
DN32 – DN50	+12 -4	+20 -6	+25 -6		

9 Weights

Basic weights of the hoselines with appropriate connections

Table 7 – Weights

Type	Weight in kg per 1000 mm of length											
	H6x6	H6x8	H6x10	H8	4H12	4H16	4H20	4SH25	4SH32	4SH40	6SP50	
A	-	-	0,510	0,580	1,27	1,77	2,47	3,40	4,63	6,22	-	
B	0,430			0,500	-	-	-	-	-	-	-	
C					1,17	1,61	2,05	3,28	4,59	6,02	11,90	
D	-	-	-	-	1,26	1,61	2,21	3,32	4,79	6,32	15,70	
E					1,29	1,81	2,27	3,60	4,91	7,04	12,90	
F	-	-	0,510	0,600	1,31	1,85	2,39	3,92	5,41	-	-	
G					1,29	1,83	2,37	3,80	5,19	-	-	

10 Materials

Standard design:

Rubber/St Hose made of rubber, fitting in electrogalvanised steel

Special steel design:

Rubber/special steel Hose made of rubber and fitting in rust and acid-resistant steel 1.4571

Referenced technical standards, codes and regulations

DIN 3017-1 Hose clamps with worm gear drive, type A
DIN 20066 Fluid power systems; Hose assemblies - Dimensions, requirements
SN 775 Hoses

Revision of July 2009

Cancelling of bill of material specification in STOR.
Section 7: Table changed to suit selection series.
Addition of section 10.
Editorial revision.